

orbit³

Digital Measurement System
Digital Linear Measuring Transducers

Features

- Accuracy to **<1 µm (0.00004 in)**
- Excellent repeatability **0.05 µm (0.000002 in)**
- Measurement ranges **0.5 to 20 mm**
- Precision linear bearings – life **100 million cycles**
- Very Low tip force **<0.18 N**
- Uses **Orbit® 3** Digital Measurement System for
 - Fast data rates
 - Simple connectivity
 - Multiple sensors on one network



Description

The Orbit® 3 Measurement System using Contact Measurement Transducers providing a cost effective solution for a wide range of gauging, measuring or positioning in diverse industries. Whether in the laboratory or in a manufacturing environment, The Orbit 3 Systems provides an extensive range of spring actuated, pneumatic and feather touch transducers offer a solution to most applications.

A **reliable transducer** is essential to any data collection and measurement system. All digital transducers are designed to generate reliable data not just from new but after millions of cycles of operation. This requires close attention to detail in design and materials as well as considerable investment in state-of-the-art machines to produce bearings, which are the heart of the transducer.

Simple connectivity up to 150 transducers on one network with a wide range of network controllers including USB and Ethernet. See the **Orbit® 3 datasheet** for further details

Customized or special products will always be considered when there is not an exact fit in our standard product range. See our specialist probe data sheets special measurement transducers including flexures and block gauges.

orbit3

Digital Linear Measuring Transducers



Standard DP Spring Push

- 0.5, 1, 2, 5, 10, and 20mm measuring ranges
- 0.7 N Tip Force
- IP 65 rating



Standard DP Pneumatic Push

- 2, 5, 10, and 20mm measuring ranges
- 0.7 N Tip Force
- IP 65 Rating
- Vacuum retract also available



DJ Pneumatic Jet

- 2, 5, and 10 mm measuring ranges
- Actuation by an inbuilt piston, independent of gaiter. Air exits via side port.
- 0.7 N Tip Force



DT Feather Touch

- As low as 0.18 N Tip Force
- Ideal for glass, electronics, and delicate surfaces
- 2, 5, 10, and 20mm measuring ranges
- Available in both spring and pneumatic

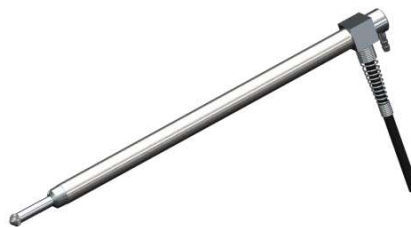

DT30 Feather Touch

- 30mm mechanical travel, with measuring range at end of travel
- 5 and 10mm measuring ranges
- As low as 0.18 N Tip Force



DW Ultra Feather Touch

- Low 0.03 to 0.06 N of tip force
- Ideal for delicate surfaces
- 10 mm measuring range
- Available in both spring and pneumatic
- Not ideal for sideload applications



D6J 6mm Narrow Body

- Thinner 6mm diameter profile
- 2mm spring available
- 5 and 10mm measuring range available
- Not ideal for sideload applications



DZ Ultra Short

- Short length probe
- 1 or 2mm measuring range

orbit3

Digital Linear Measurement Transducers / Gauging Probes

Features

- Accuracy to $<1 \mu\text{m}$
- Excellent repeatability $0.05 \mu\text{m}$
- Measurement ranges 0.5 to 20 mm .
- Precision linear bearings – life **100 million** cycles
- Very low tip force $<0.18 \text{ N}$
- Spring push, pneumatic or vacuum retract
- Excellent magnetic screening makes the Digital Probe immune from external interference



Transducer hard wired to Orbit® 3 Conditioning Electronics for best accuracy

Standard DP Transducer / Spring Gauging Probe

The standard DP range of Solartron Push transducers / probes has become the workhorse for the gauging industry. Very high resolution, excellent repeatability and accuracy coupled with high data rates comes as standard. Long life precision bearings, and an IP65 rating ensure that the transducers maintain their performance for millions of cycles. Pneumatic transducers are ideal for use in automatic gauging applications or for accessing details that would be difficult or impossible to reach with spring push transducers. With no side load applied at the contact tip, pneumatic probes ensure excellent repeatability and long life.

Special Low Force Feather Touch Transducers / Gauging Probes

Feather Touch transducers have been designed especially to gauge or measure delicate surfaces such as car windscreens, pharmaceutical bottles, electro-mechanical components and plastic parts. Whereas a traditional transducer exerts a tip force of approximately 0.7N , the Feather Touch exerts a mere 0.18N when used in the horizontal position. This reduction is achieved by replacing the gaiter with a close tolerance gland. On pneumatic versions the air leakage through the gland is restricted to less than 2.5 ml per second at 1 bar to minimise the possibility of contamination to the surface being gauged. Despite the low volume of air flow the bearing within the probe is constantly purged, avoiding the build up of dust (use of filtered air is recommended). The ultra feather touch probe has a tip force of between 0.03 and 0.06N

Replaceable nylon tips are used to guard against surface damage, although, for measuring hot glass, tungsten carbide tips can be fitted. Optional woven nylon or steel braid covering on the cable provides additional protection for applications where down time is critical.

For ultimate low force, Feather Touch Probes can be supplied without a spring. Forward and return movements are activated by pneumatic/vacuum retract, but adjustment of air pressure allows all probes to have identical tip force, constant over the entire measurement range. If the probe is mounted vertically (tip up), retraction is by the dead weight of the moving parts, eliminating the need for vacuum.

Jet (J Type) Pneumatic Transducer / Gauging Probe

J Type probes are similar to standard pneumatic transducers except that actuation is by an inbuilt piston. High tip forces are available but as air is vented through a port close to the front of the probe, they have a lower IP rating. These probes will continue to operate even if the gaiter becomes punctured.

orbit3

Digital Linear Measurement Transducers / Gauging Probes With In Line Connector

Features

- Same **high performance as Standard Digital** probe.
- In Line Connector makes installation easy as the **Probe can be separated from the electronics**
- Small Diameter Connector for ease of installation
- Connector has IP67 rating



Description

A complimentary range to the standard hard wired digital gauging transducers. The digital transducer and Orbit® 3 electronics are connected with an in line connector. The in line connector can be mounted close to the probe so that the probe can be replaced without having to unthread/thread the cable. It can also be mounted on the Orbit® 3 electronics module.

The Orbit 3 digital probe system utilizes a dedicated digital probe which has much better screening for magnetic and electrical immunity. The in line connector feature allows flexibility while maintaining a very high resolution, excellent linearity and a high data speed of the Orbit® 3 system. Probes can be replaced without any reprogramming of the controlling software.

Small diameter of the connector allows easier threading through a machine for replacement. It has a lightweight, corrosion resistant glass reinforced thermoplastic body, with IP67 protection against dust and water ingress.

orbitACS

Orbit® ACS is a specific range of products which integrate contact and non contact linear measurement transducers with an electronics module that includes an integral display. These products are excellent for a small number of measuring points, are stand alone (i.e. do not require PSIMs or Orbit® Controllers) and have an integral Modbus and ASCII interface plus flexible discrete I/O.

See separate Orbit® ACS datasheet for more details.



Technical Specification

Standard Spring Push and Pneumatic, Feather Touch and In Line Connector

Products (Dia 8h6)

Spring Push Axial Cable	DP/0.5/S	DP/1/S	DP/2/S	DP/5/S	DP/10/S	DP/20/S	DP10/2S
Spring Push Radial Cable			DPR/2/S	DPR/5/S	DPR/10/S	DPR/20/S	DPR10/2/S
Spring Push Axial Cable Feather Touch			DT/2/S	DT/5/S	DT/10/S	DT/20/S	DT10/2S
Spring Push Radial Cable Feather Touch			DTR/2/S	DTR/5/S	DTR/10/S	DTR/20/S	DTR10/2S
Pneumatic Axial Cable			DP/2/P	DP/5/P	DP/10/P	DP/20/P	DP10/2S
Pneumatic Radial Cable			DPR/2/P	DPR/5/P	DPR/10/P	DPR/20/P	DPR10/2/P
Pneumatic Axial Cable Feather Touch			DT/2/P	DT/5/P	DT/10/P	DT/20/P	DT10/2S
Pneumatic Radial Cable Feather Touch			DTR/2/P	DTR/5/P	DTR/10/P	DTR/20/P	DTR10/2S

Measurement Performance

Measurement Range (mm)	0.5	1	2	5	10	20	2
Accuracy (% of Reading) (Note 1)	0.05	0.05	0.05	0.05	0.06	0.7	0.05
Accuracy (% of Reading) (Note 1) - with In line Connector	N/A	0.2	0.2	0.15	0.15	0.15	0.2
Repeatability (worst case) μm (Note 2)	0.1	0.15	0.15	0.15	0.15	0.15	0.15
Repeatability (typical) μm (Note 3)	0.05	0.05	0.05	0.05	0.07	0.07	0.05
Resolution (μm)	0.01	0.01	0.01	0.05	0.05	0.1	0.01
Pre Travel (mm)	0.03	0.15	0.15	0.15	0.15	0.15	0.15
Post Travel (mm)	0.05	0.35	0.85	0.85	0.85	0.85	8.85
Tip Force (N) at Middle of Range $\pm 20\%$							
Spring Push	0.7	0.7	0.7	0.7	0.7	0.7	0.7
Spring Push Feather Touch	0.3	0.3	0.3	0.3	0.3	0.3	0.3
Pneumatic at 0.4 bar	N/A	N/A	0.7	0.7	0.7	0.7	0.7
Pneumatic at 1 bar	N/A	N/A	2.6	2.6	2.6	2.6	2.6
Pneumatic Feather Touch $\pm 30\%$ at 0.3 bar	N/A	N/A	0.18	0.18	0.18	0.18	0.18
Pneumatic Feather Touch $\pm 30\%$ at 1 bar	N/A	N/A	1.1	1.1	1.1	1.1	1.1
Pneumatic Jet	N/A	N/A	0.85	0.85	0.85	0.85	0.85
Temperature Coefficient %FS/ $^{\circ}\text{C}$	0.01	0.01	0.01	0.01	0.01	0.01	0.01

Environmental

Sealing for Probe	IP65 with gaiter or IP50 without gaiter IP43 for module and TCON
Sealing for Probe Interface Electronics	
Storage Temperature ($^{\circ}\text{C}$)	-20 to +80
Probe Operating Temperature with Gaiter ($^{\circ}\text{C}$)	+5 to +80
Probe Operating Temperature without Gaiter ($^{\circ}\text{C}$)	-10 to +80
Electronics Operating Temperature ($^{\circ}\text{C}$)	0 to 60
EMC Emissions	EN61000-6-3
EMC Immunity	EN61000-6-2
Probe Life	100 million cycles (no side load), > 10 million cycles in most applications

Material

Probe Body	Stainless Steel Nylon, Ruby, Silicon Nitride, Tungsten Carbide Fluoroelastomer or Silicon PUR ABS
Probe Tip (options)	
Gaiter (Note 6)	
Cable	
Electronics Module	

Electronics Interface (Orbit®3)

Orbit®3 Interface Options	USB, Ethernet, RS232
Reading Rate	3906 readings per second
Bandwidth of Electronics (Hz) user selectable	460, 230, 115, 58, 29, 14, 7, 4
Power	5 \pm 0.25 VDC @ 0.06A typical

Note 1: Accuracy 0.1 μm or % reading whichever greater

Note 2: Repeated operation against a carbide target with side load applied to the bearing using max-min

Note 3: Repeated operation against a carbide target standard deviation from average (68%)

Note 6: Different gaiter materials available for specific applications - Fluoroelastomer standard option

Ultra Feather Touch

Extreme low tip force transducer / gauging probe

Features

- Ultra low 0.03 N – 0.06 N tip force
- 0.06% of reading accuracy
- Compact package
- Different tips available, including Nylon, Ruby and Flat

Description

The Ultra Feather Touch probe utilizes a light tip force, 0.3 - 0.06 N (3-6 grams). It is a viable alternative to a non-contact sensor with various tips available in ruby and nylon. Applications include glass, rubber, semi-conductor wafers, and other delicate materials.

The 10 mm stroke UFT carries and ultra precise contact 0.06% of reading accuracy, along with a 0.15 um repeatability, and 0.01 um resolution. A

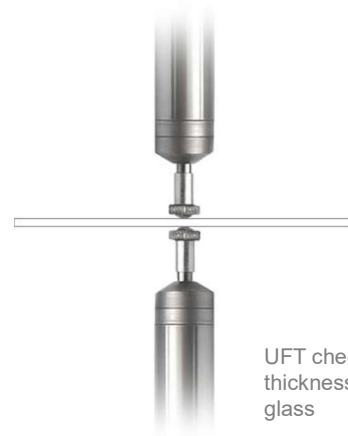

UFT checking thickness of thin glass



UFT checking a cell phone screen



UFT checking semi-conductor wafer



UFT checking Hard Disk Drive casing

Technical Specification

Ultra Low Tip Force Transducer / Gauging Probe

Products (Dia 8h6)

Spring Push Axial Cable	DW/10/S
Pneumatic Axial Cable	DW/10/P

Measurement Performance

Measurement Range (mm)	10
Accuracy (% of Reading) (Note 1)	0.06
Accuracy (% of Reading) (Note 1) - with In line Connector	0.15
Repeatability (worst case) μm (Note 2)	0.15
Repeatability (typical) μm (Note 3)	0.05
Resolution (μm)	0.01
Pre Travel (mm)	0.15
Post Travel (mm)	0.85
Tip Force (N) at Middle of Range $\pm 20\%$	
Spring Push	0.03 to 0.06
Pneumatic at 0.4 bar	0.03 to 0.06
Temperature Coefficient %FS/ $^{\circ}\text{C}$	0.01

Environmental

Sealing for Probe	IP50
Sealing for Probe Interface Electronics	IP43 for module and TCON
Storage Temperature ($^{\circ}\text{C}$)	-20 to +80
Probe Operating Temperature	-10 to +80
Electronics Operating Temperature ($^{\circ}\text{C}$)	0 to 60
EMC Emissions	EN61000-6-3
EMC Immunity	EN61000-6-2
Probe Life	> 10 million cycles with minimum side load applied.

Material

Probe Body	Stainless Steel
Probe Tip (options)	Nylon, Ruby, Silicon Nitride, Tungsten Carbide
Cable	PUR
Electronics Module	ABS

Electronics Interface (Orbit@3)

Orbit@3 Interface Options	USB, Ethernet, RS232
Reading Rate	3906 readings per second
Bandwidth of Electronics (Hz) user selectable	460, 230, 115, 58, 29, 14, 7,4

Note 1: Accuracy 0.1 μm or % reading whichever greater

Note 2: Repeated operation against a carbide target with side load applied to the bearing using max-min

Note 3: Repeated operation against a carbide target standard deviation from average (68%)

orbit3

Miniature Digital Linear Measurement Transducers / Gauging Probes

Features

- Same **high performance as Standard** Digital Transducer / Gauge Probe
- **Narrow 6 mm diameter body**
- **Ultra short**
- 1, 2, 5 and 12 mm measuring ranges
- Excellent repeatability
- Very compact and robust
- Changeable tips



Description

A novel approach to high performance yet compact Measuring and Gauging Transducers

The lack of space to fit a transducer is often a problem for gauge builders and test engineers alike. Very small transducers have usually meant a reduction in performance and / or life expectancy, but that has now changed.

The miniature gauge probe has taken a novel but practical route to solving the problem of close proximity gauging to produce the D6J / D6P range of narrow body Transducers / Gauging Probes.

Up to 25% reduction in diameter over conventional transducers has been achieved yet performance and life expectancy has been maintained, due to a completely new approach to the construction of gauge probes. Long life precision bearings ensure that probes maintain their performance for millions of cycles.

Where body length is a driving factor, the DZ range offers an alternative with up to 50% reduction in length over conventional 1mm and 2mm measuring transducers has been achieved yet performance and life expectancy has been maintained due to a completely new approach to the construction of the transducer.

Technical Specification: Narrow Body Diameter Transducers

Products (Body Dia 6h6)

Spring Push Axial Cable	D6P/2/S	D6P/5/S	N/A
Pneumatic Axial Cable	D6J/2/P	D6J/5/P	D6J/12/P

Measurement Performance

Measurement Range (mm)	2	5	12
Accuracy (% of Reading) (Note 1)	0.05	0.05	0.10
Repeatability (worst case) μm (Note 2)	0.15	0.15	0.50
Repeatability (typical) μm (Note 3)	0.05	0.05	0.25
Resolution (μm)	0.01	0.05	0.10
Pre Travel (mm)	0.15	0.15	0.15
Post Travel (mm)	0.85	0.85	0.85
Tip Force (N) at Middle of Range $\pm 20\%$			
Spring Push	0.7	0.7	N/A
Pneumatic Jet at 0.9 bar	0.7	0.7	N/A
Pneumatic Jet at 1 bar	N/A	N/A	0.7
Temperature Coefficient %FS/ $^{\circ}\text{C}$	0.01	0.01	0.01

Environmental

Sealing for Probe	IP65 with gaiter or IP50 without gaiter IP43 for module and TCON
Sealing for Probe Interface Electronics	
Storage Temperature ($^{\circ}\text{C}$)	-20 to +80
Probe Operating Temperature with Gaiter ($^{\circ}\text{C}$)	+5 to +80
Probe Operating Temperature without Gaiter ($^{\circ}\text{C}$)	-10 to +80
Electronics Operating Temperature ($^{\circ}\text{C}$)	0 to 60
EMC Emissions	EN61000-6-3
EMC Immunity	EN61000-6-2

Material

Probe Body	Stainless Steel
Probe Tip (options)	Nylon, Ruby, Silicon Nitride, Tungsten Carbide
Gaiter (Note 6)	Fluoroelastomer or Silicon
Cable	PUR
Electronics Module	ABS

Electronics Interface (Orbit@3)

Orbit@3 Interface Options	USB, Ethernet, RS232
Reading Rate	3906 readings per second
Bandwidth of Electronics (Hz) user selectable	460, 230, 115, 58, 29, 14, 7, 4
Power	5 \pm 0.25 VDC @ 0.06A typical

Note 1: Accuracy 0.1 μm or % reading whichever greater

Note 2: Repeated operation against a carbide target with side load applied to the bearing using max-min

Note 3: Repeated operation against a carbide target standard deviation from average (68%)

Note 6: Fluoroelastomer on 2mm, Silicon on 5 and 12 mm

Technical Specification: Ultra Short Transducers

Products (Dia 8h6)

Spring Push Axial Cable	DZ/1/S	DZ/2/S
Spring Push Radial Cable	DZR/1/S	DZR/2/S

Measurement Performance

Measurement Range (mm)	1	2
Accuracy (% of Reading) (Note 1)	0.1	0.1
Repeatability (worst case) μm (Note 2)	0.15	0.15
Repeatability (typical) μm (Note 3)	0.05	0.05
Resolution (μm)	0.01	0.01
Pre Travel (mm)	0.15	0.15
Post Travel (mm)	0.35	0.35
Tip Force (N) at Middle of Range $\pm 20\%$ Spring Push	0.7	0.7
Temperature Coefficient %FS/ $^{\circ}\text{C}$	0.01	0.01

Environmental

Sealing for Probe	IP65 with gaiter
Sealing for Probe Interface Electronics	IP43 for module and TCON
Storage Temperature ($^{\circ}\text{C}$)	-20 to +80
Probe Operating Temperature with Gaiter ($^{\circ}\text{C}$)	+5 to +80
Probe Operating Temperature without Gaiter ($^{\circ}\text{C}$)	-10 to +80
Electronics Operating Temperature ($^{\circ}\text{C}$)	0 to 60
EMC Emissions	EN61000-6-3
EMC Immunity	EN61000-6-2

Material

Probe Body	Stainless Steel
Probe Tip (options)	Nylon, Ruby, Silicon Nitride, Tungsten Carbide
Gaiter (Note 6)	Fluoroelastomer
Cable	PUR
Electronics Module	ABS

Electronics Interface (Orbit@3)

Orbit@3 Interface Options	USB, Ethernet, RS232
Reading Rate	3906 readings per second
Bandwidth of Electronics (Hz) user selectable	460, 230, 115, 58, 29, 14, 7, 4

Note 1: Accuracy 0.1 μm or % reading whichever greater

Note 2: Repeated operation against a carbide target with side load applied to the bearing using max-min

Note 3: Repeated operation against a carbide target standard deviation from average (68%)

Standard Spring Push DP/S

	DP/2/S	DP10/2/S	DP/5/S	DP/10/S	DP/20/S
A	47.50	75.00	66.40	90.50	127.00
C	2.00	4.00	2.00	2.00	3.00
B1	13.90	24.40	17.40	25.40	44.90
B2	10.90	14.40	11.40	14.40	23.90

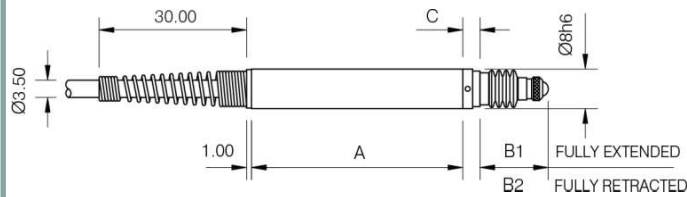

A R/A adapter kit is available for axial probes where space is limited – see website

For R/A version A is -3 mm

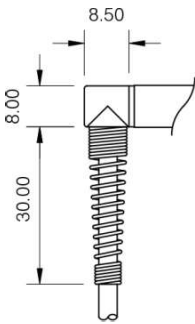

Feather Touch Spring Push DT/S

	DT/2/S	DT/5/S	DT/10/S	DT/20/S
A	47.50	66.40	90.50	127.00
C	2.00	2.00	2.00	3.00
B1	13.90	17.40	25.40	33.90
B2	10.90	11.40	14.40	12.90

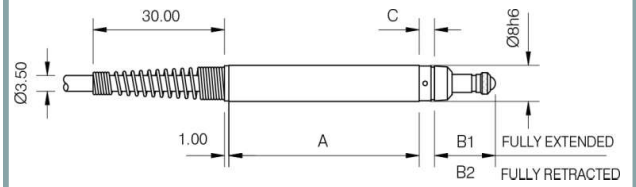

Vacuum Retract (DP/V)

	DP/2/V	DP/5/V	DP/10/V	DP/20/V
A	46.00	65.00	96.00	127.00
C	2.00	2.00	2.00	3.00
B1	13.90	17.40	25.40	44.90
B2	10.90	11.40	14.40	23.90

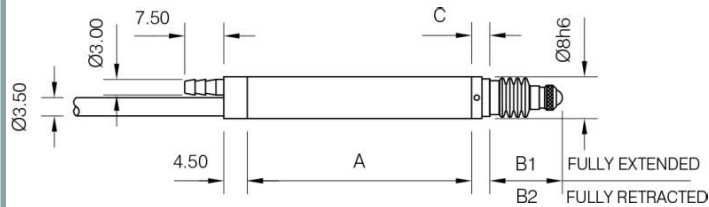

6mm dia body Spring Push (D6P2)

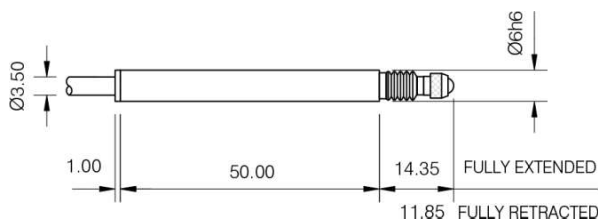

Feather Touch Spring Push DT/S

	DTR/2/S	DTR/5/S	DTR/10/S	DTR/20/S
A	33.50	52.50	76.50	113.50
C	2.00	2.00	2.00	3.00
B1	13.90	17.40	25.40	33.90
B2	10.90	11.40	14.40	12.90

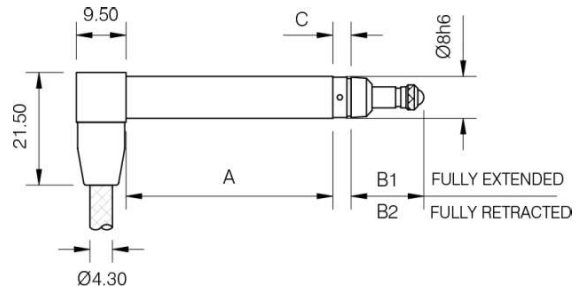

Ultra Short Spring Push (DP/0.5/S)

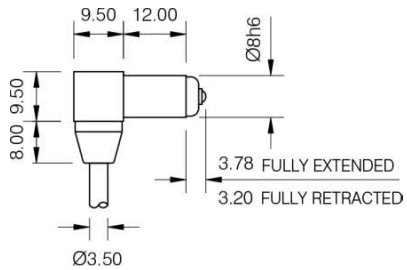

Ultra Short Spring Push (DZ/S)

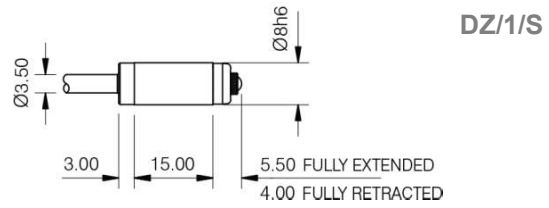

DZ/1/S

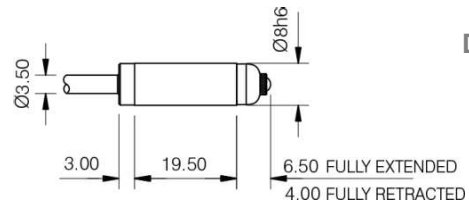

DZ/2/S

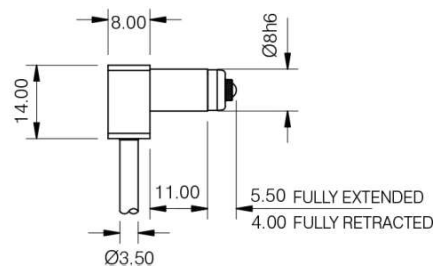

DZR/1/S

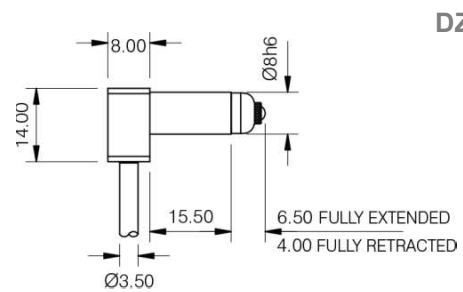

DZR/2/S

Pneumatic Push DP/P

	DP/2/P	DP10/2/P	DP/5/P	DP/10/P	DP/20/P
A	52.50	84.00	71.00	96.00	127.00
C	2.00	2.00	1.00	2.00	3.00
B1	13.90	25.40	17.40	25.40	44.90
B2	10.90	10.90	11.40	14.40	23.90

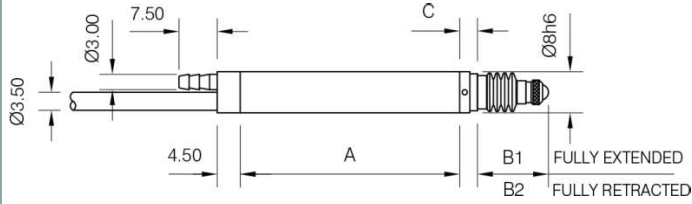

Feather Touch Pneumatic Push DT/P

	DT/2/T	DT/5/T	DT10/T	DT20/T
A	52.50	71.00	96.00	127.00
C	2.00	2.00	2.00	3.00
B1	13.90	17.40	25.40	33.90
B2	10.90	11.40	14.40	12.90

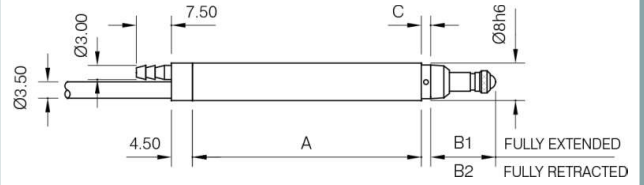

**Right Angled Pneumatic Push (DTR/P)
90° output**

	DTR/2/P	DTR/5/P	DTR/10/P	DTR/20/P
A	38.50	57.50	82.50	113.50
C	2.00	2.00	2.00	3.00
B1	13.90	17.40	25.40	33.90
B2	10.90	11.40	14.40	12.90

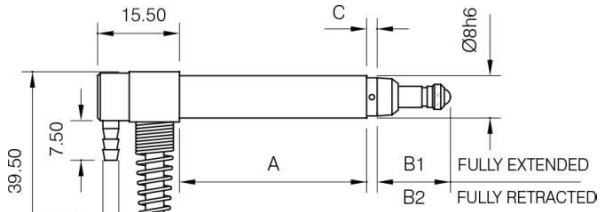

Non Braided Cable

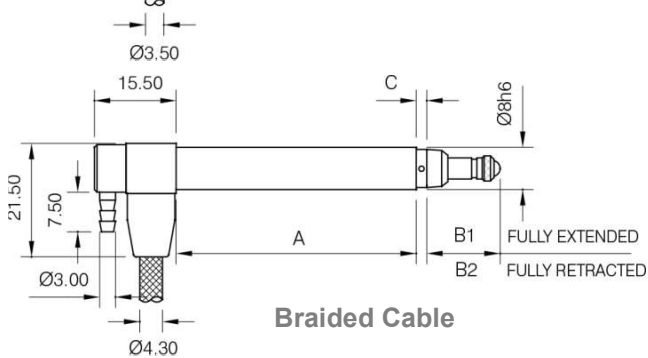

Braided Cable

**Gaiter Independent Pneumatic Push (DJ/P)
90° output**

	DJ/2/P	DJ10/2/P	DJ/5/P	DJ/10/P
A	52.00	84.00	71.00	96.00
C	7.00	7.00	7.00	7.00
B1	15.40	26.90	18.90	26.90
B2	12.40	15.90	12.90	15.90

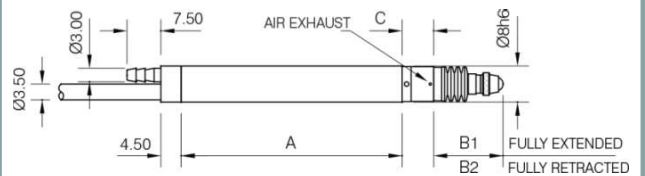

**Gaiter Independent 6mm dia body Pneumatic
(D6J/2/P)**

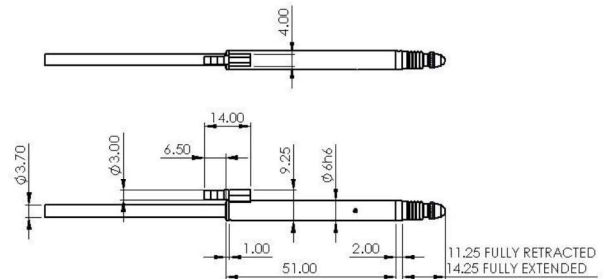

Ultra Feather Touch Pneumatic Push

